

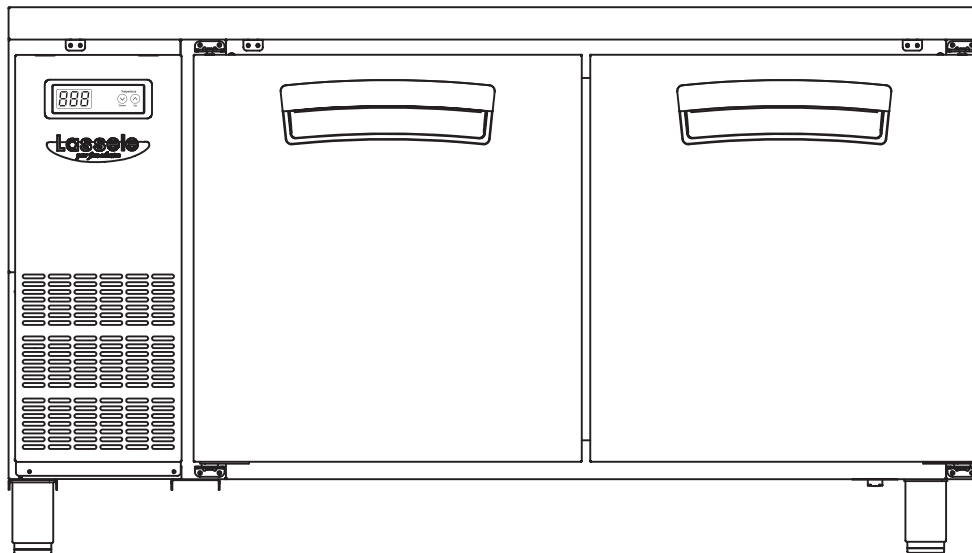

Operating Instruction Lassele Refrigerated Counters



< SIDE TABLE >

BASIC, GN TYPE, GLASS DOOR, SALAD, SALAD HOOD, DRAWER

Please read this user manual before you use this product.
If you request unnecessary services, you may waste money.
Thus, fix simple troubles by yourself which you have found.

R512A-774

Table of Contents

1. Comprehension and preparation

(1) Part name	4
(2) How to ground	10
(3) Caution	11

2. How to use

Installation	15
Temperature control	17

3. References

(1) Proper usage	18
(2) Cautions	19
(3) Cleaning.....	20
(4) Troubleshooting tips	21
(5) Before you call for service	22
(6) Product dimension	23



- The temperature inside refrigerator depends on the frequency of door opening and closing, volume of food stored and the circumstance under which the product is installed.
- Set the temperature control at Weak if food in the refrigerator is a little.
- After a power outage or after the power cord is reconnected, the temperature previously selected will automatically be displayed.
- Don't cool or freeze water or meat stock in the product as it may change other sorts of food in it. Use a refrigerator for meat stock to cool or freeze it.



Notices

- In the case that the ambient temperature of the product is below 10°C (50°F), food in refrigerator may be frozen.
- Set the temperature control according to the conditions of the ambient temperature.
- Don't touch the vessels or food in refrigerator with a wet hand. Your hand may be frost-bitten.
- Don't keep drugs, academic materials, herbal tonics (liquor made from deer antler or dog) or medicinal herbs in the product. – The company will not be responsible for spoiled drugs, academic materials, herbal tonics or medicinal herbs.

**The merits
of the
product**

Glossy Appearance

Lustrous Stainless Steel brightens a room.

Power-saving Design

The product is designed to reduce greatly electric bills.

Powerful Cooling System

Rapid and powerful cooling system keeps your food fresh and safe longer without the loss of nutrition.

Low Noise and High Efficiency Compressor

The product with a compressor designed for Low Noise and High Efficiency makes quiet and powerful operation possible.

Safe Design

Built-in self test equipment which informs a rise in room temperature and a safe device which perceives the disorder of compressor are adopted.

Check Local electric rating.

*Plug into exclusive power socket.

*Don't plug into multi-socket.

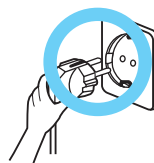

***Make sure to read and follow this manual before you use the product.**

Part name

Appearance LNRT-1A/1B/C-900, LNRT-2A/2B/C-1200/1500, LNRT-3A/3B/C-1800(Refrigerator only)
LNFT-1A/1B/C-900, LNFT-2A/2B/C-1200/1500, LNFT-3A/3B/C-1800(Freezer only)

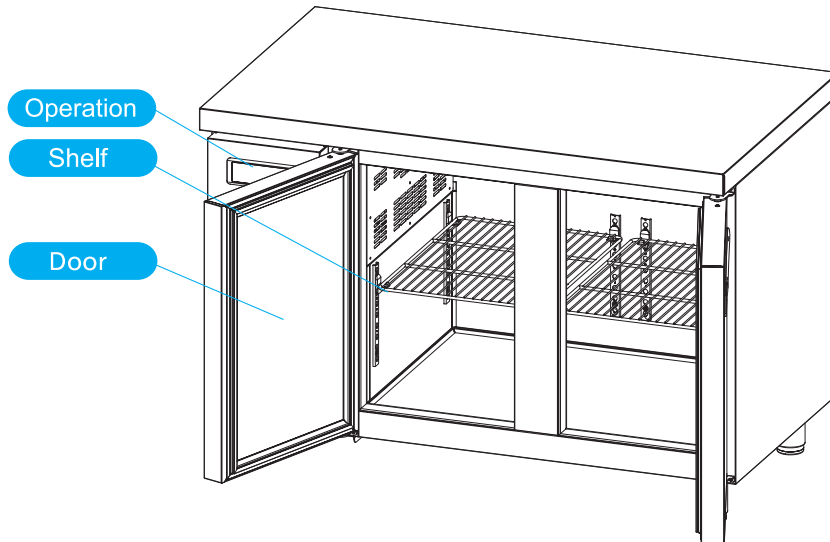

Appearance LERT-1B/C-900, LERT-2B/C-1200/1500, LERT-3B/C-1800(Refrigerator only)
LEFT-1B/C-900, LEFT-2B/C-1200/1500, LEFT-3B/C-1800(Freezer only)

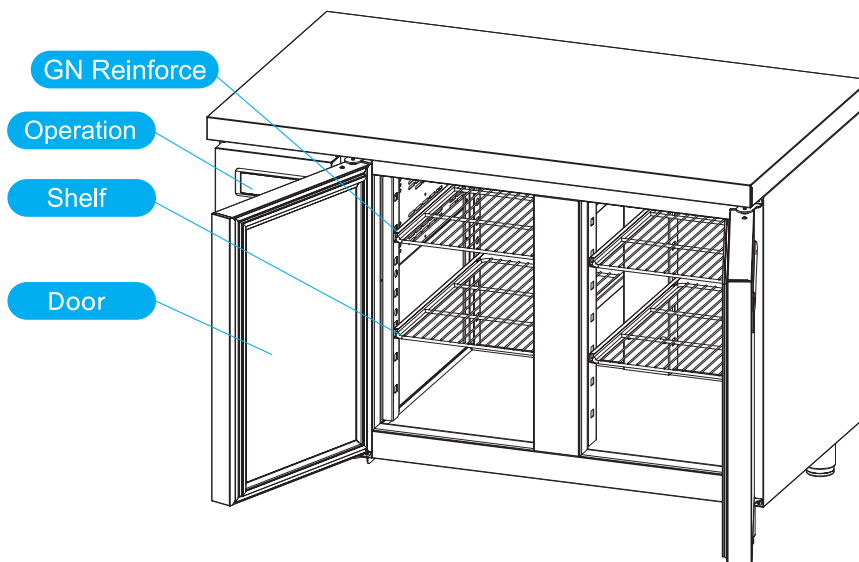

※ The door quantity depends on the model specification.

Part name

Appearance LGRT-1B/C-900, LGRT-2B/C-1200/1500, LGRT-3B/C-1800(Refrigerator only)

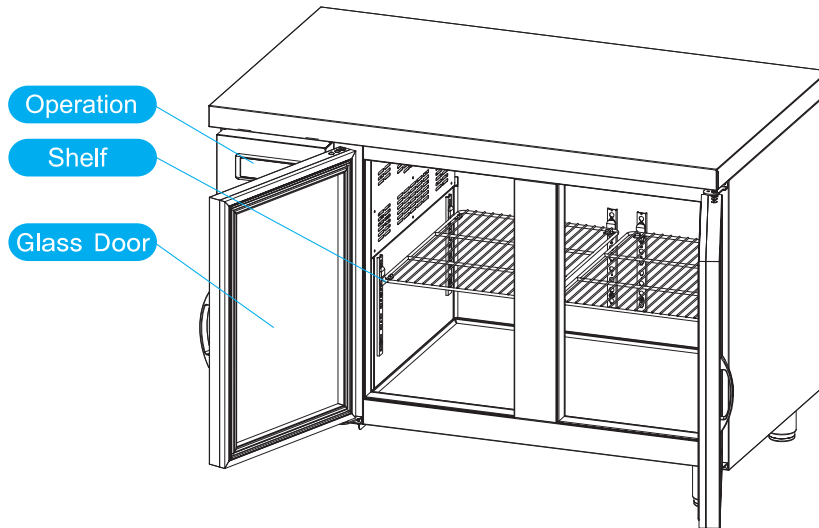

Appearance LEGRT-1B/C-900, LEGRT-2B/C-1200/1500, LEGRT-3B/C-1800(Refrigerator only)

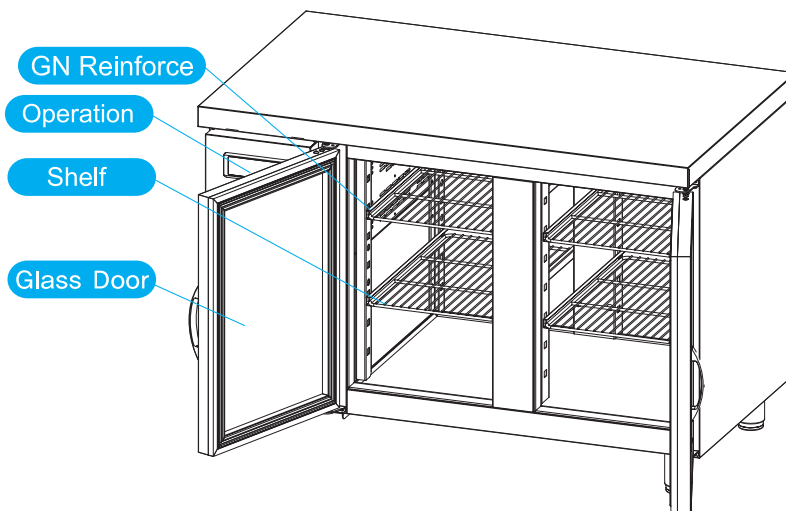

※ The door quantity depends on the model specification.

Part name

Appearance LNRT-1B/C-90-V, LNRT-2B/C-12VV, LNRT-2B/C-15VV, LNRT-3B/C-18-VVV

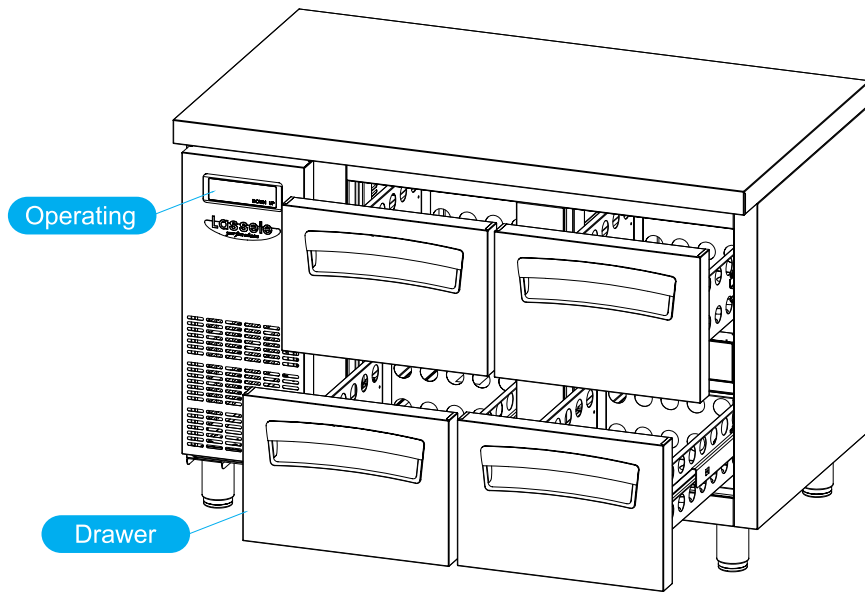

※ The door quantity depends on the model specification.

Part name

Appearance LHRT-1B/C-900, LHRT-2B/C-1200, LHRT-2B/C-1500, LHRT-3B/C-1800 (Refrigerator only)

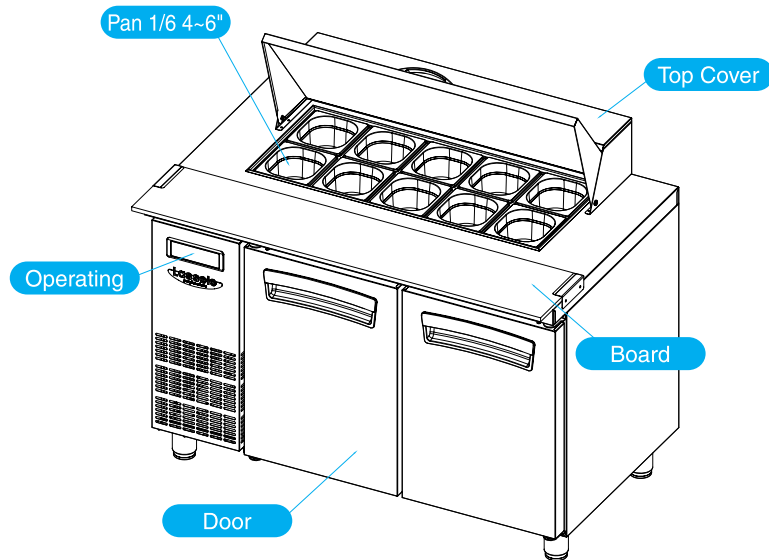

Appearance LSRT-1B/C-900, LSRT-2B/C-1200, LSRT-2B/C-1500, LSRT-3B/C-1800 (Refrigerator only)

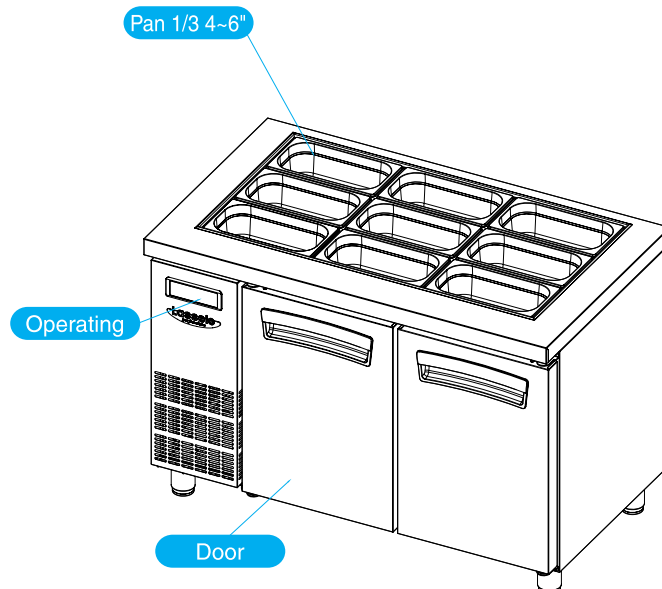

※ The door quantity depends on the model specification.

Part name

Appearance LNRT-1B-1200, LNRT-2B-1800(Refrigerator only)
LNFT-1B-1200, LNFT-2B-1800(Freezer only)

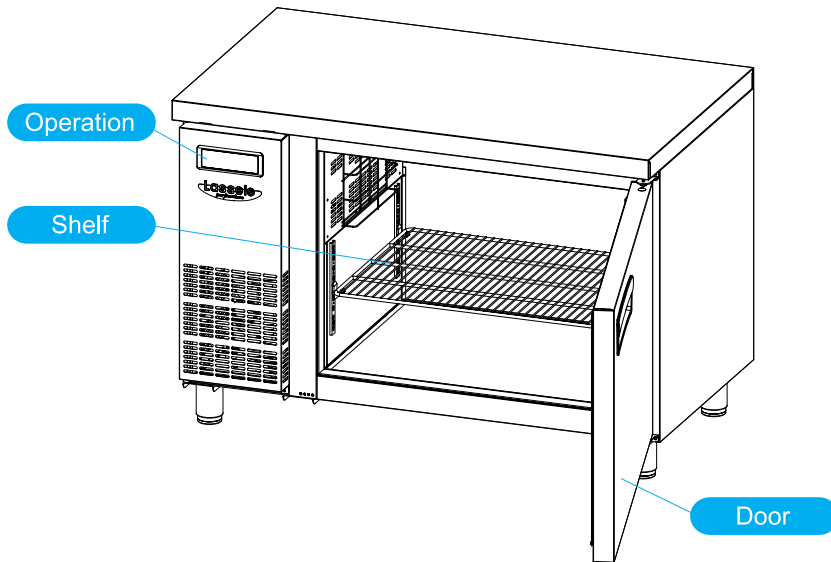

Appearance LHRT-1B-1200, LHRT-2B-1800(Refrigerator only)

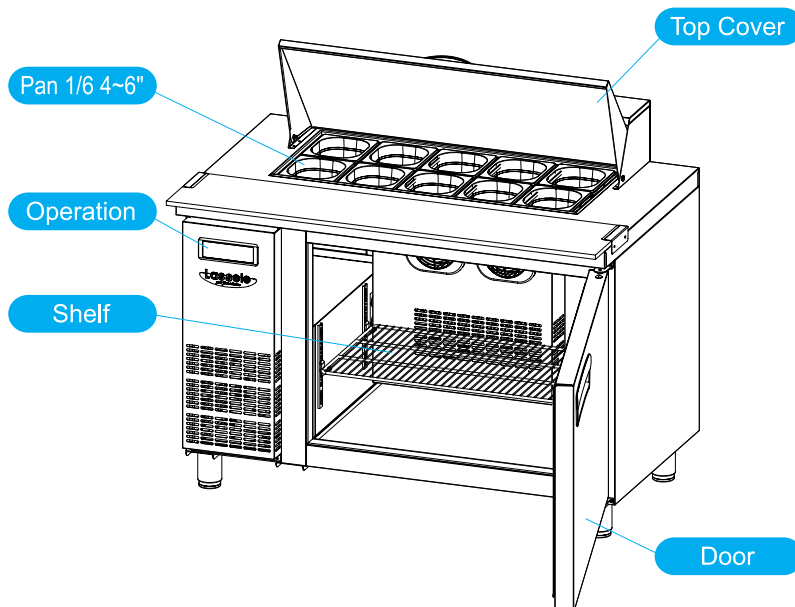

※ The door quantity depends on the model specification.

Part name

Appearance LSRT-1B-1200, LSRT-2B-1800(Refrigerator only)

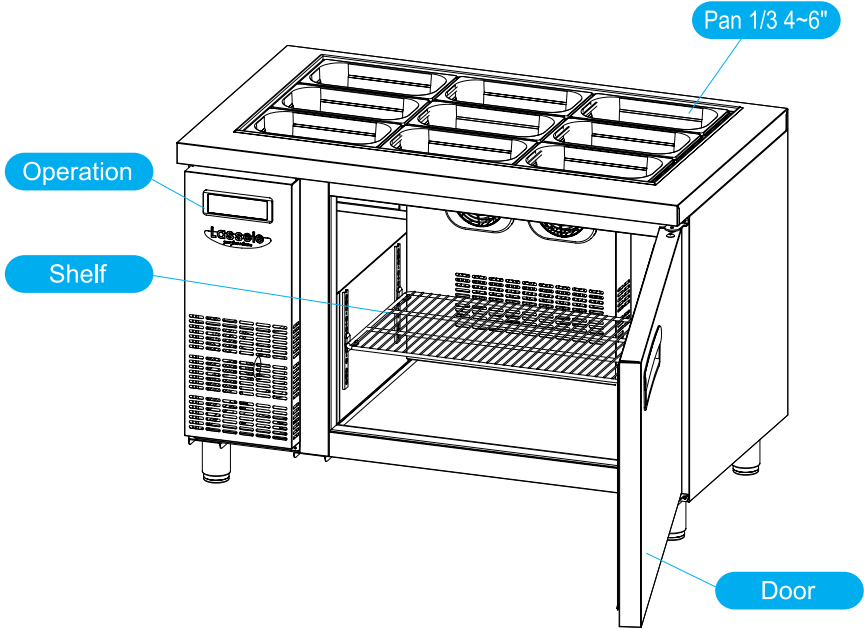

How to ground

Connect a ground wire to prevent problems such as power leakage or electric shock.

- * Power outlet for the product must be grounded

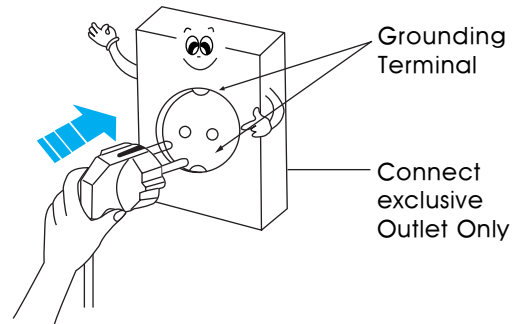

- * Power connection must be made using a safety plug socket earthed according to the regulations. Follow local regulations!

–After connecting a ground wire to a copper ground plate, bury the wire beneath ground.
Size of copper plate: Over 0.7mm thick
Over 900cm² wide

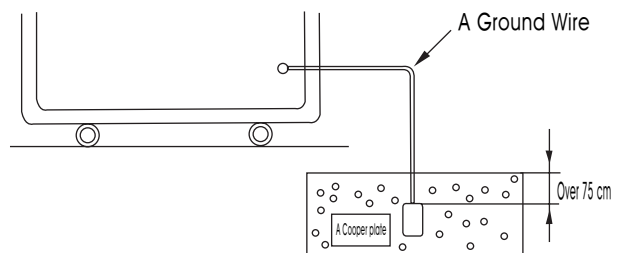

–Connect the wire to a properly grounded outlet

- ※ The places where a ground wire can't be connected

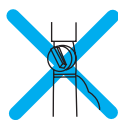

a gas pipe



water pipe



telephone wire

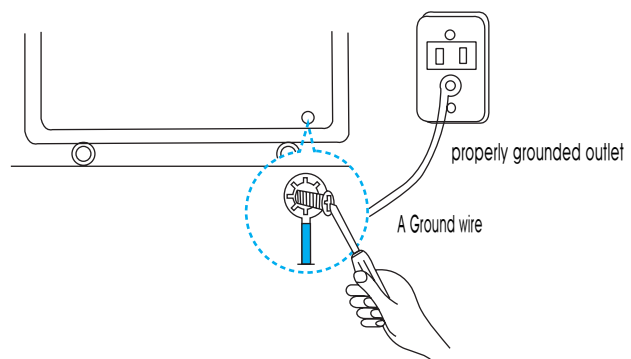

Never use the product for other purposes except for keeping food.

Especially, don't let children play in the product. If the door of the product is closed, they may choke.

Caution







- As the proper use of product can prevent danger or physical loss, you should observe general cautions to use it safely.

The contents of warning and caution









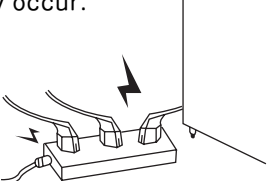

 **Warning** A man may die or may be seriously injured.

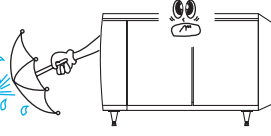
 **Caution** A man may be wounded or suffer from a physical loss.

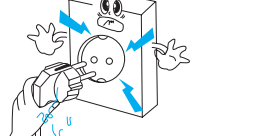
The contents of signs

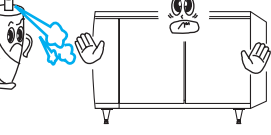
-  The sign represents NO.
-  The sign represents NO DISASSEMBLING.
-  The sign represents NO TOUCHING.
-  You must observe it.
-  You must unplug the power cord from outlet.
-  The sign represents the protective grounding to prevent any electric shock.

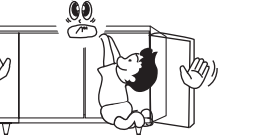
Warning

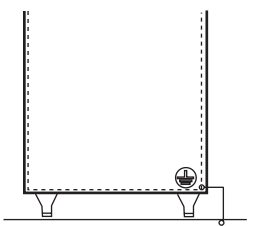
<p>Don't overload an electrical outlet with several appliances or extension cords</p> <ul style="list-style-type: none"> • Electrical overheating and fire may occur. <p> </p>	<p>Don't spray water directly inside or outside of refrigerator</p> <ul style="list-style-type: none"> • Fire or electric shock may occur. <p> </p>	<p>Don't touch an electric plug, electrical components and operating part located to the left side of the refrigerator with a wet hand</p> <ul style="list-style-type: none"> • You may be shocked electrically or your hand may be injured. <p> </p>
<p>Don't spray flammable and combustible materials around the product</p> <ul style="list-style-type: none"> • A burst or fire may occur. <p> </p>	<p>Don't let children sit on or go in the product. Don't detach shelves to keep them separately</p> <ul style="list-style-type: none"> • If children enter the product, their lives may be dangerous. <p> </p>	<p>Make sure that the grounding wire is connected</p> <ul style="list-style-type: none"> • If the grounding wire has not been connected, a disorder or electric shock may occur. <p> </p>



Warning

Don't keep volatile and flammable materials in the product

- If benzene, thinners, alcohol, ether, LP gas and medicines are kept in it, they may burst.



No



Never disassemble, fix and convert it arbitrarily. Especially, don't let children play, control or operate it

- The wrong operation may cause fire, electric shock or damage.



No disassembling

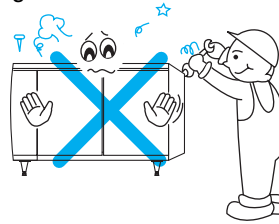

If gas escapes, you should not touch the product and its plug, and you should ventilate at once

- There is a real fire risk and burn risk once tiny spark bursts into open flame.



Observe

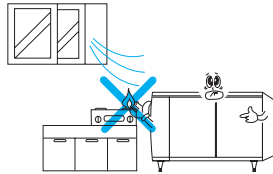

Remove doors and their packing when discarding the product

- Especially, don't let children play in the product. If the door of product is closed, they may choke.
- Please contact the place where you purchased the product or a consumer service center for additional information.



Observe

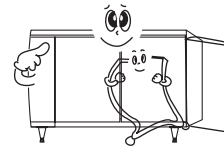

Don't break, modify, bend with force, stretch or twist an electric cord: If the cord is damaged, fire or electric shock may occur.



No

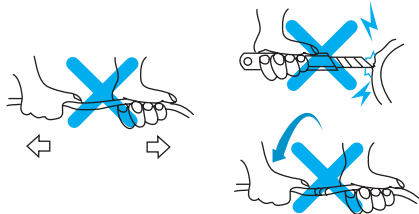

Make sure that an electric plug is not pressed by the rear side of the product. Put it where it is easy to use the plug

- If the electric plug is damaged, fire caused by overheating may occur.



No

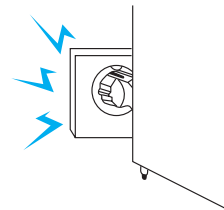

Remember to unplug the power cord when thunder and lightning occur and when you don't use it for a long time.

- Even though you don't use the product, it may be overheated if the power cord remains plugged. There is also fire or electric risk.
- The appliance must be positioned so that the plug is accessible.



Unplug the power cord.

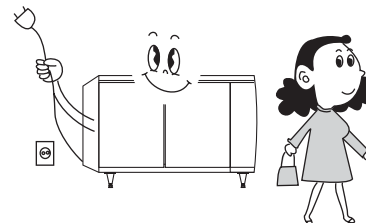



Caution

Install the product where rodents (mouse and so on) are not present: If they gnaw the wire, fire may occur.



Observe

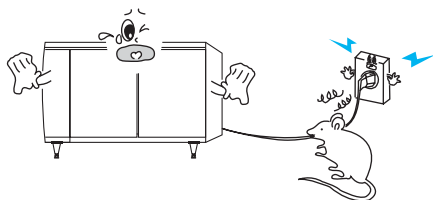

If abnormal conditions (strange sound, smell and smoke) are founded, unplug the power cord immediately, and then contact the appointed customer service center.



Unplug the power cord

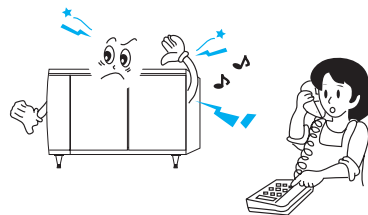

When disconnect the power cord, pull on the plug, not the cord itself

- Pulling on the cord can damage the cord and may result in fire or electric shock.



No

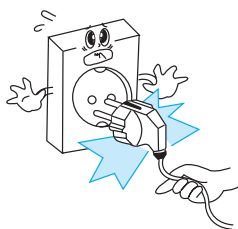

As the product is heavy, several people should move it together

- Don't lay it while carrying.



Observe

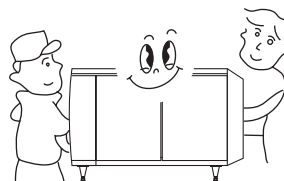

Don't touch food or containers in the refrigerator with wet hands

- Your hands may be frostbitten.



No



Don't put the bowls filled with water, drugs and small metals around the machine room on the left side of the product

- There is an electric shock, fire and burst risk or you may be hurt. The longevity of the product may be reduced. Its cooling function may weaken. It may result in malfunction.



No

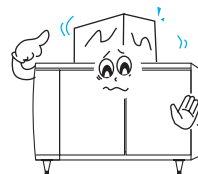

Use a door knob when closing the refrigerator door

- If you close the door with other parts except door knob, your fingers may be hurt



Observe

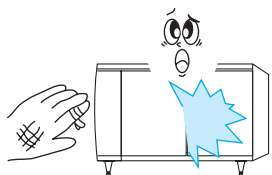

Don't pack the refrigerator with too much food

- If the food pours down while opening the door, you may be hurt. Cooling efficiency would be decreased accordingly.



No

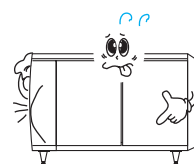



Caution

Keep drugs, reagents, academic materials, herbal tonics (liquor made from deer antler or dog) and medicinal herbs

- If things which require the strict temperature control are put in the product, they may spoil or their unexpected reaction may result in a hazard.
- The company is not responsible for drugs, academic materials, reagents and herbal tonics spoiled by the trouble of the product.



No



Don't cling to the door or climb to the upper part of product. It is very dangerous

- The product may fall down or you may be hurt. Especially, let children be careful.
- The company doesn't compensate according to the Consumer Protection Laws for damages or losses which have occurred owing to unstable action.



No

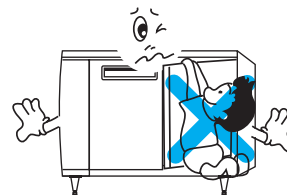

Make sure that plug pins are not wet with water or there is not dirt stuck around the pins. Insert the plug fully into the outlet not to be shaken

- If dirt or foreign substances are stuck to the pins, or the plug is connected unstably, fire may occur.



Observe

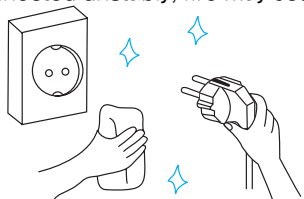

If you want to reconnect the power plug after you have pulled it off, replug it at least in 5 minutes.

- If a cooler works too hard, it may result in a trouble.



Observe

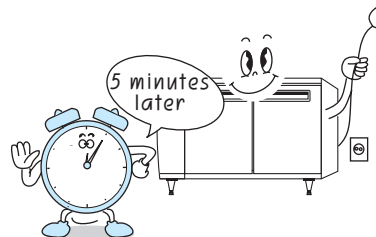

Don't plug the power plug if the hole of outlet is too big. It may result in an electric shock or fire.



No

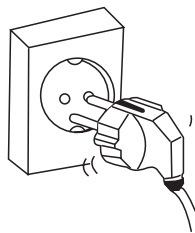

Don't put your hands in a part of the product or its left machine room. They may be hurt.

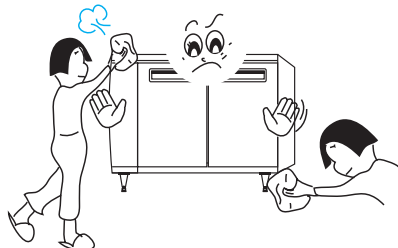

Do not leave too much food on the shelf of the cool chamber.

- * Maximum carrying capacity of the shelf is under 30kg.
- * The shelf might be bent in case of over 30kg.



No

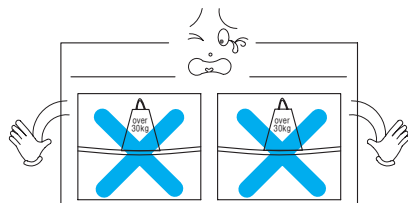

Installation

Install the product indoors

- It is indoor use only. If it is installed outdoors, the product may be damaged or its cooling efficiency may be decreased.

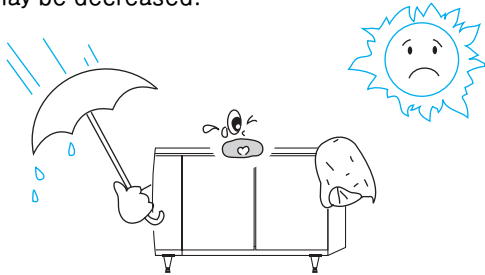

Install the product on the firm and even floor

- The unstable installation may result in vibration and noise of the product. If the floor where the product is supposed to be installed is not flat, put a strong board on it.
- Fasten the product not to be shaken by turning the height control screws of fixing legs to the left.

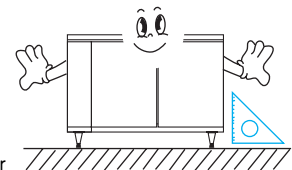
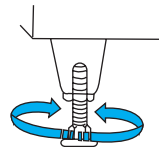

Turn the screw to the left to increase the height of product or turn it to the right to decrease it.

Avoid the place where there is much corrosive gas to install it

- If the ambient temperature is high, cooling efficiency will be reduced and electric fee will be increased.
- The color of its appearance may be changed or its longevity may be reduced by briquette or corrosive gas.

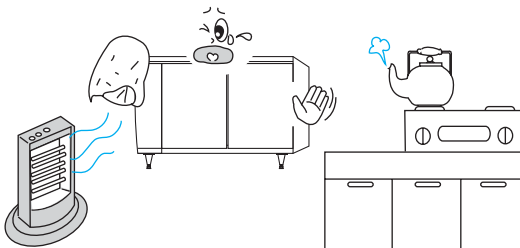

Install the product under a shelf or where there is nothing to fall down on the top.

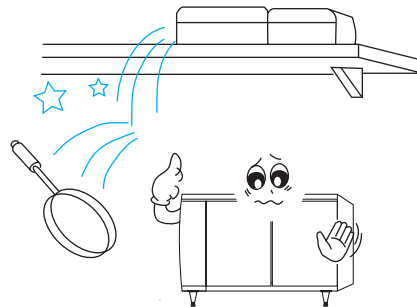

Install it in a well-ventilated area

- As cooling efficiency gets better in the well-ventilated area, allow adequate space around the refrigerator for good air circulation as follows.

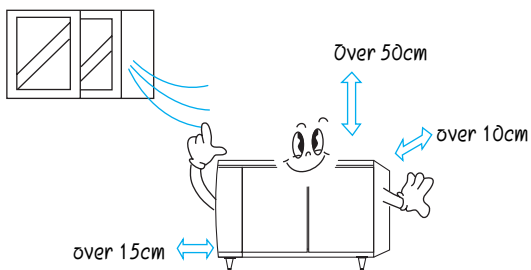

When the product is installed in a basement or in a wet or damp place

- In the case that the product is installed in a basement or in a wet or damp place, purchase an earth leakage circuit breaker from an agent or after-sales service center and then connect it to the outlet. Electric leakage breaker.

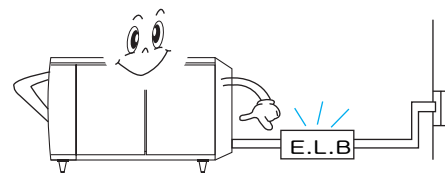

Avoid places that are damp, dusty or where water splashes

- If you install the product in a place which is damp or subject to water, it may result in a power leakage. If dust is piled up a lot in a machine room, condensation may be reduced and cooling efficiency may be decreased.

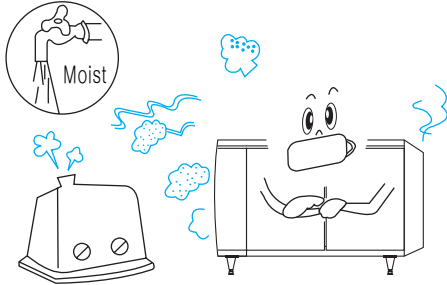

Avoid places that are exposed to direct sunlight or excessive heat

- Avoid places that are exposed to direct sunlight and excessive heat like electric or gas heater.

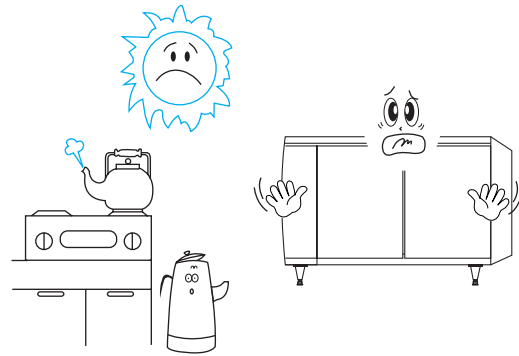



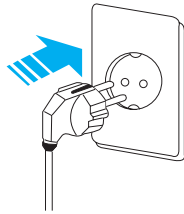



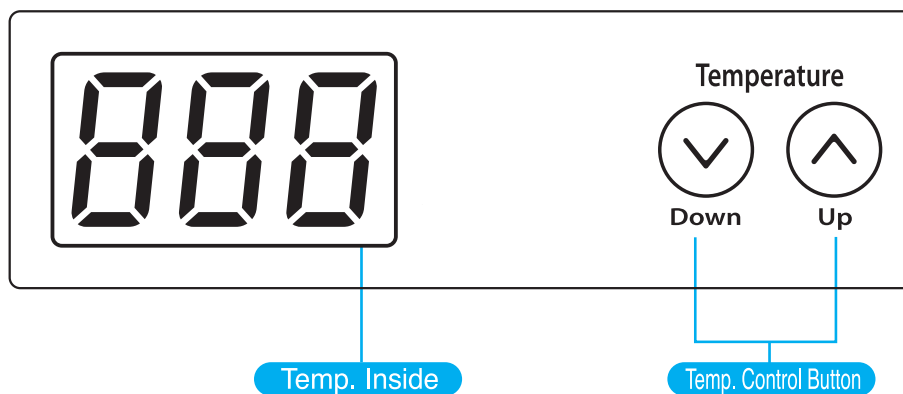

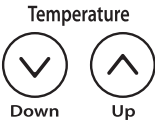

Connect a power plug into an electric outlet when 2-3 hours have passed after installation. If the supply cord is damaged, it must be replaced by the manufacturer or its service agent or qualified person in order to avoid any hazard.



Temperature control



	<ul style="list-style-type: none"> ● Continuous 5 second press on the button  will toggle the power On/Off. <ul style="list-style-type: none"> - If you turn the power off during operation, every power becomes shut down. At this moment if the power is turned on, the fan motor inside the room will be activated immediately and the comp will start operation after 5 minutes of delay. ● One time push of the  or  button will make the set temperature changed. ● Continuous 3 second press on the button  will change the defrost frequency (5H, 8H). ● Press  and  at the same item for 3 sec and "SEL" will appear on the display. <ul style="list-style-type: none"> Press  once and "dS" will appear on the display. Press  once to activate Force Defrost and "dF" will appear on the display while the Force Defrost is activating. After 30 minutes from the defrost activation if the temperature sensor inside the room senses the 5 degree C, then the forced defrost stops. 	 <ul style="list-style-type: none"> ● Refrigerator : +7°C ~ 0°C (Other Market : 39°F ~ 28°F) ● Freezer : -3°C ~ -24°C (Other Market : 5°F ~ -9°F)
---	---	--

Proper usage

Don't pack the refrigerator with too much food

- As cooling circulation gets worse owing to too much food, cooling time gets longer. Keep food at proper intervals. (If you put food at the bottom of product, cooling circulation becomes poor. Thus, keep food on shelves.)

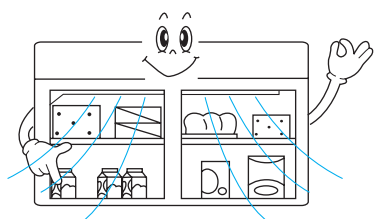

Keep food when 2 ~ 3 hours have passed

- Put food into the refrigerator when 2 ~ 3 hours have passed since it starts working, that is, when the inside of product gets fully cold.

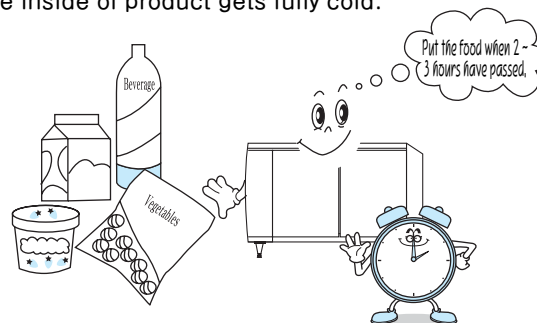

Wait until hot food is cooled down and then keep it.

- If you put hot food directly, it may make its surrounding food spoil and electric fee will be increased.

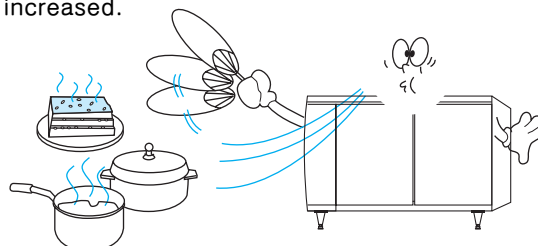

Wash and then keep vegetables or fruits.

- Keep vegetables or fruits after washing and wiping them. Clean bottled or packed food not to soil other foods and then keep it.

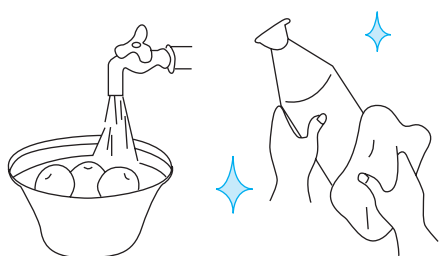

Put food into plastic bags or containers with a cover before keeping them in the product.

- Put juicy or smelly food into plastic bag or containers with a cover. They prevent food from being dry and changed. Thus, food can be kept longer and the smell inside the refrigerator can be reduced.
- Take food after expiration date out of the refrigerator.

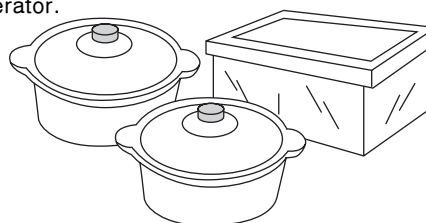

Cautions

When you don't use the product for a long time

- Take food out of the refrigerator and unplug the power cord.
- Clean up and wipe the inside of product and then dry the inside for 2~3 hours.
- If someone enters the unused refrigerator and then its door is closed, it is very dangerous. Thus, insert something between the door and a body of the product not to be closed completely.

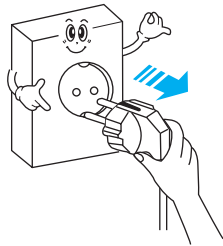

When power is off

- Don't open the door more frequently than you need to.

When power is supposed to be off

- Avoid keeping new food because it raises the temperature inside the product

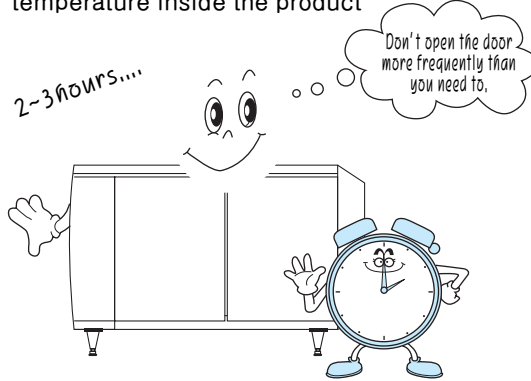

When tiny water droplets are formed

- Tiny water droplets may be formed when humidity around the product is high or it rains. This phenomenon occurs when moisture in the air reach the cold side of refrigerator. Then, wipe the product with a dry towel.

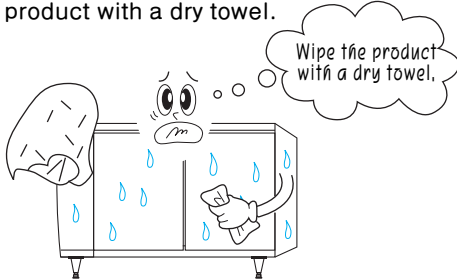

When you carry or move the product

- Be sure to unplug the power cord when you carry or move the product.
- Be sure to carry the product with several people as it is very heavy.
- See the manual when you operate again the product after placing it.

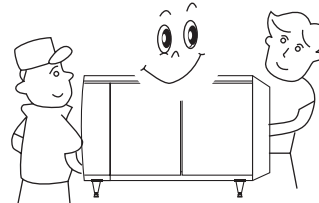

Don't open the door more frequently than you need to.

- The frequent door opening may reduce cooling efficiency as the cold air in the product comes out.

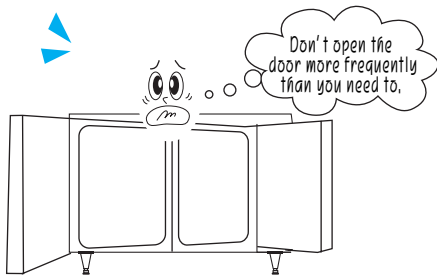

Don't operate the product with the power plug.

- If you operate the product with the power plug, you may be shocked electrically.

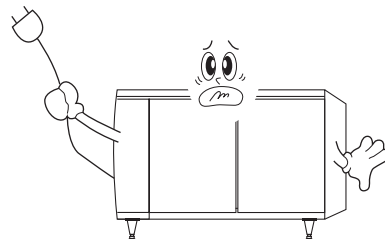

Cleaning

Before you clean the product

- Clean the product once a month. If you clean it frequently, you can keep it clean and use it for a long time.
- Unplug the power cord.
- Especially, don't sprinkle water directly on the top of machine room to clean the product. It may cause power leakage and it may have the product tarnished.
- Don't sprinkle water directly to clean the product.

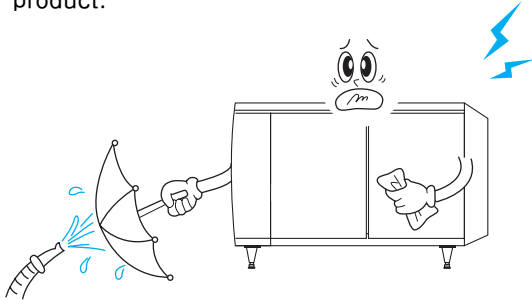

Washing the inside and outside of the product

- Wash it with a soft cloth soaked in warm water.
- Wash its serious stain with a soft cloth soaked in neutral detergent. In the case that you use neutral detergent, be sure to wash it with clean water and to wipe completely dampness with a dry cloth.
- You can detach and wash shelves.
- Don't use thinner, benzene, oil, boiling water, a rough brush, abrasive and hydrochloric acid which can change the color and form of the product.

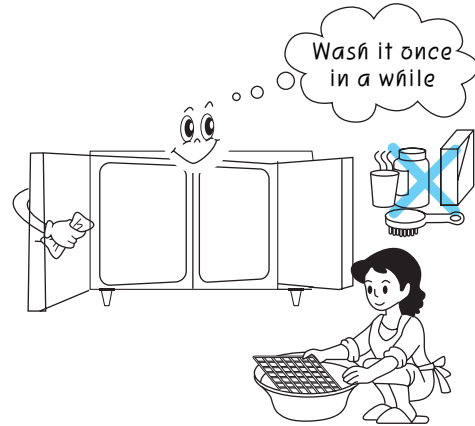

Packing of door (Door Gasket)

- If you keep using door gasket stained with juice or lactobacillus beverage, the gasket may be damaged in rapid. Especially, its lower part is apt to be dirty. Thus, wash it with a soft cloth soaked in a neutral detergent and wipe it with a clean cloth.

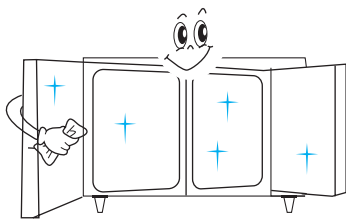

After cleaning

- After cleaning, close the door tightly as food or other things may prevent the door packing from being adhered to the body of the product. Make sure that it is adhered to the body completely.
- Make sure that the power cord is not damaged.
- Make sure that electrical overheating is not found from the power plug..
- Make sure that the power plug is connected to the outlet completely.
- Please read the user's manual thoroughly before you use this product.

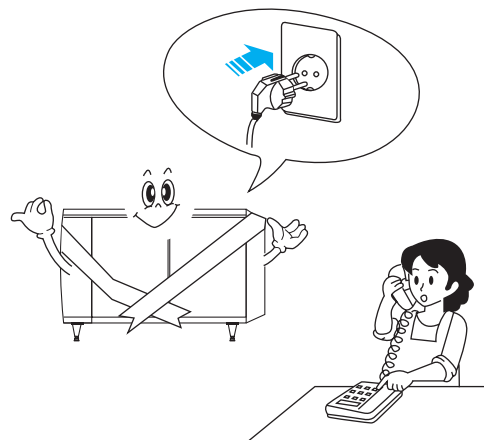

Troubleshooting Tips

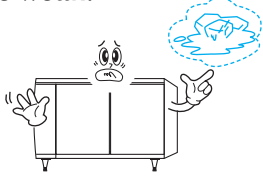
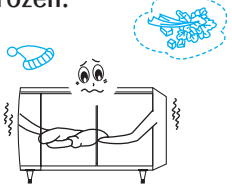
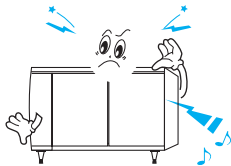
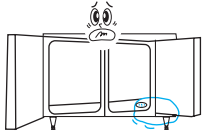
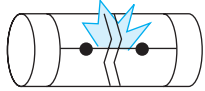
Diagnosis	Checking	Arrangement
<p>Cooling system doesn't work. Cooling function is weak.</p> 	<ol style="list-style-type: none"> 1. Is the power plug connected properly? 2. Isn't temperature control set at "weak"? 3. Isn't the product exposed to direct sunlight and heaters? 4. Isn't the rear side of refrigerator too close to the wall? 5. Don't you open the door more frequently than you need to? Is the door closed tightly? 6. Don't you put anything on the left side of machine room? 	<ol style="list-style-type: none"> 1. Connect the power plug. 2. Press the temperature button to set at "strong" 3. Avoid places that are exposed to sunlight or heaters. 4. Allow the space over 10cm from the back and side of the product. 5. Close the door tightly and don't open it too frequently. 6. Don't put anything on the left side of machine room for free air circulation. Otherwise, cooling efficiency may be decreased.
<p>Food in a refrigerator compartment is frozen.</p> 	<ol style="list-style-type: none"> 1. Isn't the temperature control set at "strong"? 2. Isn't the surrounding temperature below 10°C (50°F)? 3. Isn't juicy food put where cold air comes out? 	<ol style="list-style-type: none"> 1. Press the temperature control to set at "weak". 2. In the case that the surrounding temperature is below 10°C (50°F), move the product to a place whose surrounding temperature is in the range of 10°C~35°C (50°F~95°F). 3. Put juicy food at the front side of shelves.
<p>You hear abnormal noise.</p> 	<ol style="list-style-type: none"> 1. Isn't the floor slant or weak to install the product? 2. Isn't the back side of the product too close to the wall? 3. Isn't there anything at the back and side of the product? 	<ol style="list-style-type: none"> 1. Install the product where the floor is even and firm. 2. Allow the space over 10cm from the back and side of the product. 3. Don't keep anything at the back and the side of the product.
<p>Water drops come down at the bottom of the refrigerator.</p> 	<ol style="list-style-type: none"> 1. Don't insects or foreign substances block the drainage at the rear side of the product? 	<ol style="list-style-type: none"> 1. Seal the juicy food before putting it in the refrigerator. 2. Detach and wash the drainage from the right back inside the refrigerator.
<p>A fuse has a short circuit.</p> 	<ol style="list-style-type: none"> 1. Don't you use a fuse whose capacity is different or other substitutes? 2. Isn't fuse broken? 	<ol style="list-style-type: none"> 1. Never use a fuse whose capacity is different or other substitutes. 2. Take a fuse out of a fuse holder and see if it is broken. If so, change the fuse with the same capacity fuse supplied to you after checking its rated voltage and electric current. Put the fuse into the fuse holder in the same way. <p>* Notice: Be sure to unplug the power cord from an outlet before changing the fuse</p>

Before you call for service

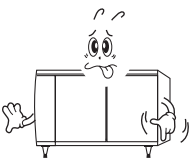
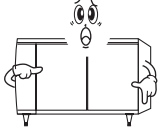
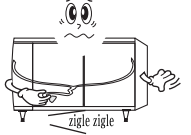
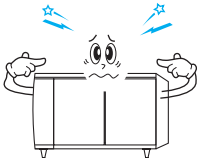
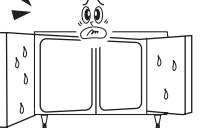
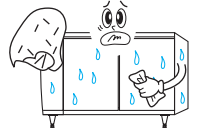
Cases	No troubles.
<p>The front side of product is hot.</p> 	<p>⇒ Hot wires have been installed to prevent tiny water droplets from being formed. Especially, when the product is installed at first or during summer, you may feel that the product is hot but it is not out of order.</p>
<p>The refrigerator door doesn't work too well.</p> 	<p>⇒ In the case that you open the door again within 5~10 seconds after opening and closing the door, the door may not open very well owing to the difference of the inside pressure.</p> <p>⇒ Wait for dozens of seconds and then open it, and it will open easily.</p>
<p>You hear a sound that water flows. (Ex: Gurrhk, zigle zigle, bukbuk)</p> 	<p>⇒ It is the sound of refrigerants flowing to cool the inside of product.</p>
<p>You hear a sound, "tuk tuk" from the inside of product. (Ex: tuk tuk, dalgrak, woong~, dulkung)</p> 	<p>⇒ It is the sound occurred when the product starts operating at first and the sound occurred when the compressor and motor work. You may feel the sound is big at first, but if the product works normally, the sound will be decreased after a while.</p> <p>⇒ When the refrigerator temperature goes back to its "normal" temperature, the compressor stops operating and then such sound as tuk tuk and dalgrak may occur. However, it is not out of work.</p>
<p>Tiny water droplets are formed in the refrigerator compartment.</p> 	<p>⇒ In the case that the surrounding temperature and humidity are high, the refrigerator door remains open for a while or juicy food is kept without a cover, water droplets may be formed.</p>
<p>Tiny water droplets are formed in the outside of product.</p> 	<p>⇒ In the case that the surrounding humidity of the product is high or that it rains during the rainy season, water droplets may be formed in the outside of product.</p> <p>This phenomenon occurs when moisture in the air reaches the cold side of the refrigerator and when humidity is very high. Then, wipe them with a dry towel.</p>

Product dimension

* Basic Model

Names of models Classification		LNRT-1B/C -900	LNRT-2B/C -1200	LNRT-2B/C -1500	LNRT-3B/C -1800	LNFT-1B/C -900	LNFT-2B/C -1200	LNFT-2B/C -1500	LNFT-3B/C -1800
Net Storage Capacity		213 ℓ	300 ℓ	411 ℓ	521 ℓ	213 ℓ	300 ℓ	411 ℓ	521 ℓ
Weight		67(69)Kg	82(84)Kg	92(94)Kg	112(114)Kg	69(71)Kg	84(86)Kg	94(96)Kg	114(116)Kg
Size(WxDxH)		900x700(750)x850	1200x700(750)x850	1500x700(750)x850	1800x700(750)x850	900x700(750)x850	1200x700(750)x850	1500x700(750)x850	1800x700(750)x850
Names of models Classification		LNRT-1A -900	LNRT-2A -1200	LNRT-2A -1500	LNRT-3A -1800	LNFT-1A -900	LNFT-2A -1200	LNFT-2A -1500	LNFT-3A -1800
Net Capacity		197 ℓ	296 ℓ	375 ℓ	474 ℓ	197 ℓ	296 ℓ	375 ℓ	474 ℓ
Net Weight		60Kg	70Kg	79Kg	91Kg	64Kg	75Kg	90Kg	100Kg
Size(WxDxH)		900x600x850	1200x600x850	1500x600x850	1800x600x850	900x600x850	1200x600x850	1500x600x850	1800x600x850
Range of temperature	Refrigerator	+7°C ~ 0°C (Other Market : 39°F~28°F)							
	Freezer	-3°C ~ -24°C (Other Market : 5°F~-9°F)							
	Conditions	The outside temperature 30°C(86°F), unloading, not while exposed to sunlight							
Temperature Control		Temperature Control by MICOM							
Method of defrosting	Refrigerator	Cycle defrosting							
	Freezer	Defrost heater							
Accessories	Shelves	1EA	2EA	2EA	3EA	1EA	2EA	2EA	3EA
	Shelf Clip	4EA	8EA	8EA	12EA	4EA	8EA	8EA	12EA
	LEG	4EA	4EA	4EA	4EA	4EA	4EA	4EA	4EA
	Castor(Optional)	4EA	4EA	4EA	4EA	4EA	4EA	4EA	4EA

* GN Model

Names of models Classification		LERT-1B/C -900	LERT-2B/C -1200	LERT-2B/C -1500	LERT-3B/C -1800	LEFT-1B/C -900	LEFT-2B/C -1200	LEFT-2B/C -1500	LEFT-3B/C -1800
Net Storage Capacity		213 ℓ	300 ℓ	411 ℓ	521 ℓ	213 ℓ	300 ℓ	411 ℓ	521 ℓ
Weight		65(67)Kg	80(82)Kg	90(92)Kg	110(112)Kg	67(69)Kg	82(84)Kg	92(94)Kg	112(114)Kg
Size(WxDxH)		900x700(750)x850	1200x700(750)x850	1500x700(750)x850	1800x700(750)x850	900x700(750)x850	1200x700(750)x850	1500x700(750)x850	1800x700(750)x850
Range of temperature	Refrigerator	+7°C ~ 0°C (Other Market : 39°F~28°F)							
	Freezer	-3°C ~ -24°C (Other Market : 5°F~-9°F)							
	Conditions	The outside temperature 30°C(86°F), unloading, not while exposed to sunlight							
Temperature Control		Temperature Control by MICOM							
Method of defrosting	Refrigerator	Cycle defrosting							
	Freezer	Defrost heater							
Accessories	Shelves	2EA	4EA	4EA	6EA	2EA	4EA	4EA	6EA
	Shelf Clip	2EA	8EA	8EA	12EA	2EA	8EA	8EA	12EA
	LEG	4EA	4EA	4EA	4EA	4EA	4EA	4EA	4EA
	Castor(Optional)	4EA	4EA	4EA	4EA	4EA	4EA	4EA	4EA

* Glass Model

Names of models		LGRT-1B/C	LGRT-2B/C	LGRT-2B/C	LGRT-3B/C	LEGRT-1B/C	LEGRT-2B/C	LEGRT-2B/C	LEGRT-3B/C
Classification		-900	-1200	-1500	-1800	-900	-1200	-1500	-1800
Net Storage Capacity		213 l	300 l	411 l	521 l	213 l	300 l	411 l	521 l
Weight		70(72)Kg	90(92)Kg	100(102)Kg	125(127)Kg	72(74)Kg	92(94)Kg	102(104)Kg	127(129)Kg
Size(WxDxH)		900x700(750)x850	1200x700(750)x850	1500x700(750)x850	1800x700(750)x850	900x700(750)x850	1200x700(750)x850	1500x700(750)x850	1800x700(750)x850
Range of temperature	Refrigerator	+7°C ~ 0°C (Other Market : 39°F~28°F)							
	Conditions	The outside temperature 30°C(86°F), unloading, not while exposed to sunlight							
Temperature Control		Temperature Control by MICOM							
Method of defrosting	Refrigerator	Cycle defrosting							
Accessories	Shelves	1EA	2EA	2EA	3EA	2EA	4EA	4EA	6EA
	Shelf Clip	4EA	8EA	8EA	12EA	-	-	-	-
	GN rail	-	-	-	-	2EA	8EA	8EA	12EA
	LEG	4EA	4EA	4EA	4EA	4EA	4EA	4EA	4EA
	Castor(Optional)	4EA	4EA	4EA	4EA	4EA	4EA	4EA	4EA

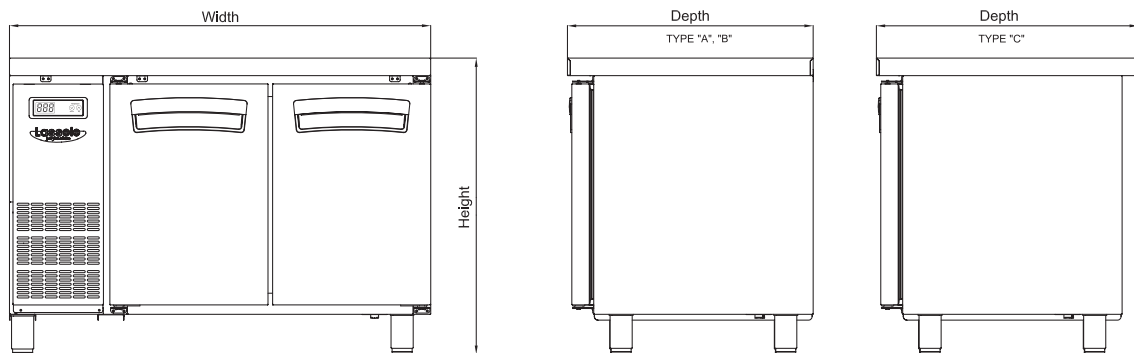

* Drawer Model

Names of models		LNRT-1B/C -90-V	LNRT-2B/C -12-VV	LNRT-2B/C -15-VV	LNRT-3B/C -18-VVV
Classification					
Net Storage Capacity		213 l	300 l	411 l	521 l
Weight		73(75)Kg	94(96)Kg	106(108)Kg	129(131)Kg
Size(WxDxH)		900x700x850	1200x700x850	1500x700x850	1800x700x850
Range of temperature	Refrigerator	+7°C ~ 0°C (Other Market : 39°F~28°F)			
	Conditions	The outside temperature 30°C(86°F), unloading, not while exposed to sunlight			
Temperature Control		Temperature Control by MICOM			
Method of defrosting	Refrigerator	Cycle defrosting			
	Accessories				
	Drawer	2EA	4EA	4EA	6EA
	Rail	2PAIR	4PAIR	4PAIR	6PAIR
	Leg	4EA	4EA	4EA	4EA

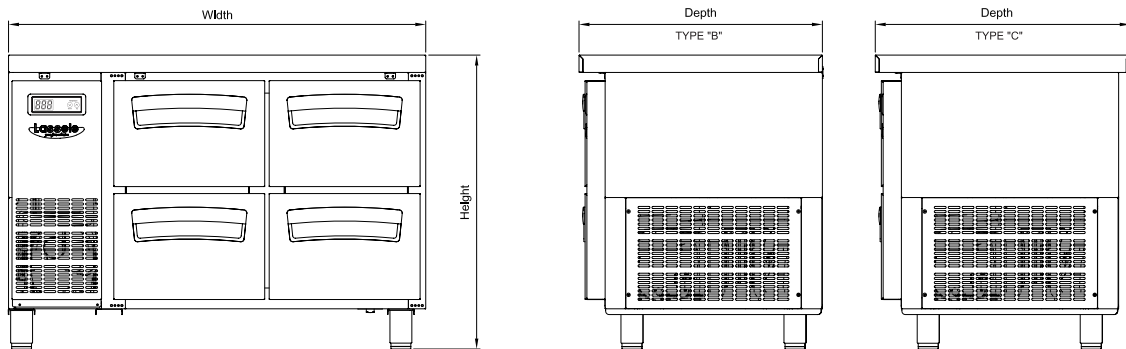

*** Side Salad Table**

Names of models Classification		LSRT-1B/C-900	LSRT-2B/C-1200	LSRT-2B/C-1500	LSRT-3B/C-1800
Net Storage Capacity		213 ℓ	300 ℓ	411 ℓ	521 ℓ
Weight		65(67)Kg	77(79)Kg	88(90)Kg	99(101)Kg
Size(WxDxH)		900x700(750)x850	1200x700(750)x850	1500x700(750)x850	1800x700(750)x850
Range of temperature	Refrigerator	+7°C ~ 0°C (Other Market : 39°F~28°F)			
	Conditions	The outside temperature 30°C(86°F), unloading, not while exposed to sunlight			
Temperature Control		Temperature Control by MICOM			
Method of defrosting		Cycle defrosting			
Accessories	Shelf	1EA	2EA	2EA	3EA
	Shelf Clip	4EA	8EA	8EA	12EA
	LEG	4EA	4EA	4EA	4EA
	Castor(Optional)	4EA	4EA	4EA	4EA

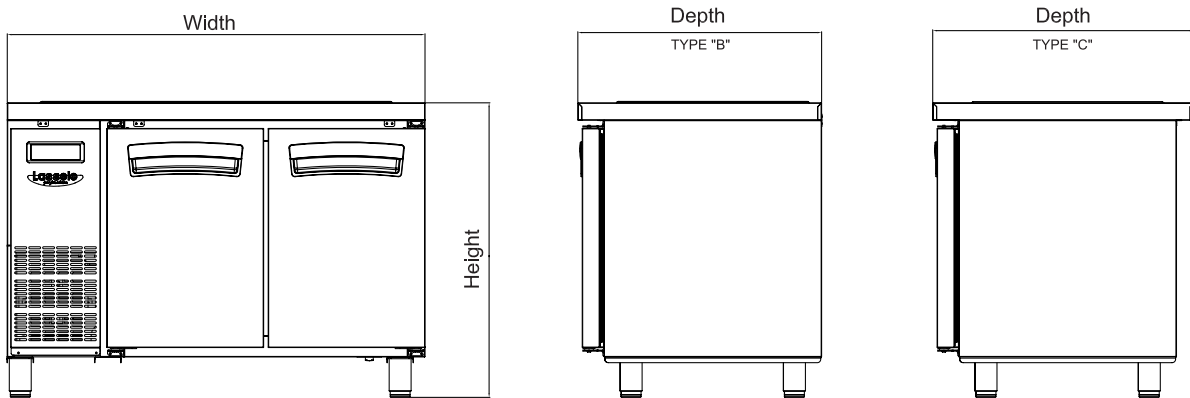

*** Side Salad Table Hood**

Names of models		LHRT-1B/C-900	LHRT-2B/C-1200	LHRT-2B/C-1500	LHRT-3B/C-1800
Classification					
Net Storage Capacity		213 ℓ	300 ℓ	411 ℓ	521 ℓ
Weight		77(79)Kg	91(93)Kg	108(110)Kg	125(127)Kg
Size(WxDxH)		900x700(750)x1030	1200x700(750)x1030	1500x700(750)x1030	1800x700(750)x1030
Range of temperature	Refrigerator	+7°C ~ 0°C (Other Market : 39°F~28°F)			
	Conditions	The outside temperature 30°C(86°F), unloading, not while exposed to sunlight			
Temperature Control		Temperature Control by MICOM			
Method of defrosting		Cycle defrosting			
Accessories	Shelf	1EA	2EA	2EA	3EA
	Shelf Clip	4EA	8EA	8EA	12EA
	LEG	4EA	4EA	4EA	4EA
	Castor(Optional)	4EA	4EA	4EA	4EA

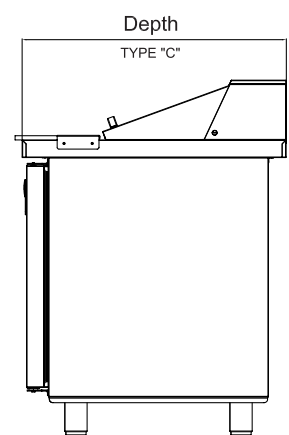
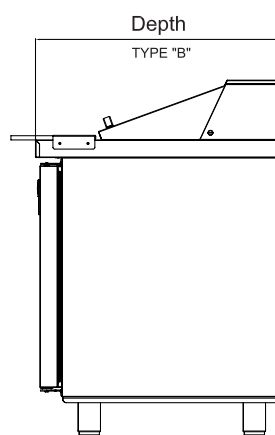
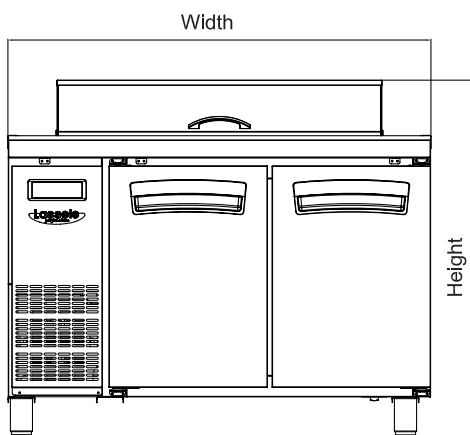

*** Wide Door**

Names of models		LNRT-1B -1200	LNRT-2B -1800	LNFT-1B -1200	LNFT-2B -1800	LSRT-1B -1200	LSRT-2B -1800	LHRT-1B -1200	LHRT-2B -1800
Classification									
Net Storage Capacity		300 ℓ	521 ℓ	300 ℓ	521 ℓ	300 ℓ	521 ℓ	300 ℓ	521 ℓ
Weight		81Kg	111Kg	83Kg	113Kg	76Kg	98Kg	90Kg	124Kg
Size(WxDxH)		1200x700x850	1800x700x850	1200x700x850	1800x700x850	1200x700x850	1800x700x850	1200x700x850	1800x700x850
Range of temperature	Refrigerator	+7°C ~ 0°C (Other Market : 39°F~28°F)							
	Freezer	-3°C ~ -24°C (Other Market : 5°F~-9°F)							
	Conditions	The outside temperature 30°C(86°F), unloading, not while exposed to sunlight							
Temperature Control		Temperature Control by MICOM							
Method of defrosting	Refrigerator	Cycle defrosting							
	Freezer	Defrost heater							
Accessories	Shelves	1EA	2EA	1EA	2EA	1EA	2EA	1EA	2EA
	Shelf Clip	4EA	8EA	4EA	8EA	4EA	8EA	4EA	8EA
	LEG	4EA	4EA	4EA	4EA	4EA	4EA	4EA	4EA
	Castor(Optional)	4EA	4EA	4EA	4EA	4EA	4EA	4EA	4EA

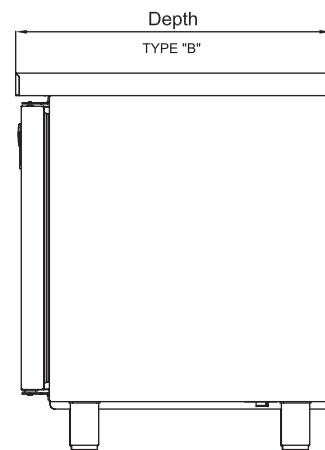
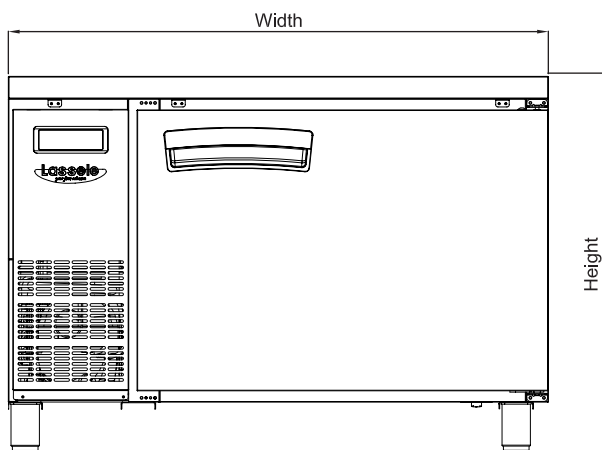



MEMO



MEMO



MEMO

Manufacturer : **DAEYEONG E&B**

ANSAN-SI, GYEONGGI-DO, REPUBLIC OF KOREA

TEL 82-31-491-1091

FAX 82-31-491-0325

www.daeyeong.co.kr